

Data Sheet

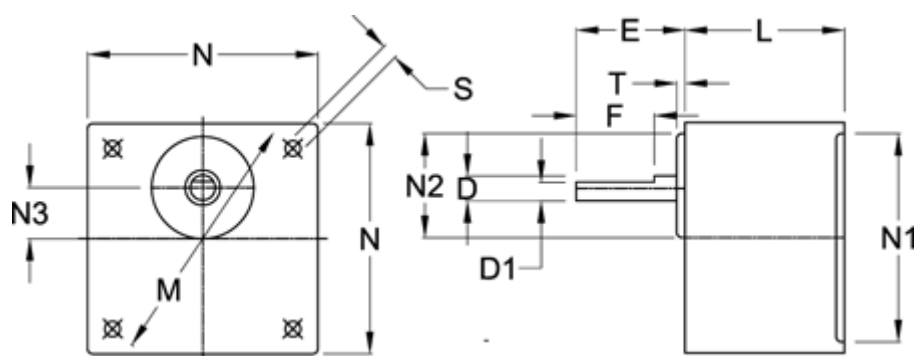

Article number: 72009005032
Description: Gear Head SP5B I=5
Pinion input

Measures



D = 12	N2 = 38
D1 = 9.5	N3 = 18
E = 35	S = 4xø6,5
F = 25	T = 5
L = 42	
M = 104	
N = 90	
N1 = 83	